

Cobra®

Operating Instructions

The Cobra line of quality products includes:

- CB Radios
- microTALK® Radios
- Radar/Laser Detectors
- Safety Alert® Traffic Warning Systems
- Mobile GPS Navigation Systems
- HighGear® Accessories
- CobraMarine® VHF Radios
- CobraMarine® Chartplotters
- Power Inverters
- Accessories

For more information or to order any of our products, please visit our website:

www.cobra.com



2500 WATT POWER INVERTER
CPI 2575

Printed in China
Part No. 490-401-P
Version A

Nothing Comes Close to a Cobra®

Nothing Comes Close To A Cobra™

Introduction



Our Thanks to You

Thank you for purchasing the Cobra CPI 2575 inverter. Properly used, this Cobra product will give you many years of reliable service.

How Your Cobra Power Inverter Works

The Cobra power inverter is an electronic product that has been designed and built to take low voltage DC (Direct Current) power from your automobile or other low voltage power supplies and convert it to standard 115 volt AC (Alternating Current) power like the current you have in your home. This conversion process thereby allows you to use many of your household appliances and electronic products in automobiles, RVs, boats, tractors, trucks and virtually anywhere else.

Customer Assistance

Customer Assistance

Should you encounter any problems with this product, or not understand its many features, please refer to this owner's manual. If you require further assistance after reading this manual, Cobra Electronics offers the following customer assistance services:

For Assistance in the U.S.A.

Automated Help Desk English only.
24 hours a day, 7 days a week 773-889-3087 (phone).

Customer Assistance Operators English and Spanish.
8:00 a.m. to 6:00 p.m. CT, Monday through Friday
(except holidays) 773-889-3087 (phone).

Questions English and Spanish.
Faxes can be received at 773-622-2269 (fax).

Technical Assistance English only.
www.cobra.com (on-line: Frequently Asked Questions).
English and Spanish. productinfo@cobra.com (e-mail).

For Assistance Outside the U.S.A.

Contact Your Local Dealer

A1

©2008 Cobra Electronics Corporation
6500 West Cortland Street
Chicago, Illinois 60707 USA
www.cobra.com

Features

- Three AC Receptacles
- Voltage & Power Meter
- Remote On/Off Capable
- Automatic Thermal Protection/Shutdown
- Reverse Polarity Protection
- Low Battery Alarm
- Low Battery Shutdown

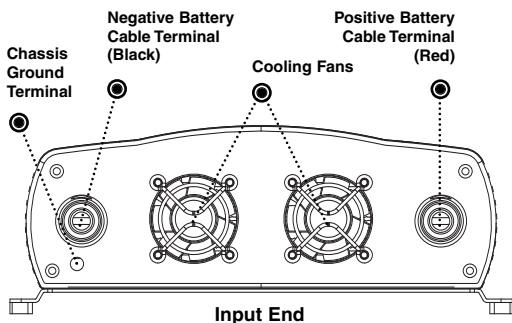
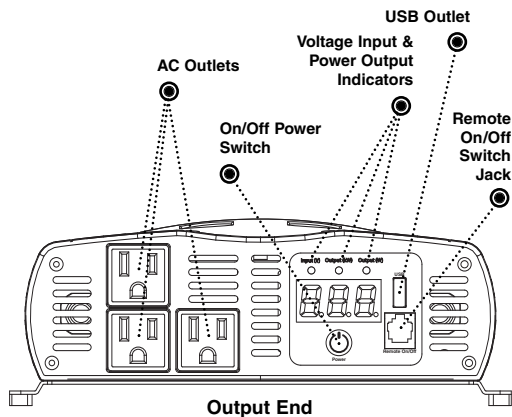

Introduction

Our Thanks to You A1

Customer Assistance A1

Product Features A2

Important Safety Information 1

Quick Evaluation Before Installation 4



Installation

Installation Requirements 6

Mounting 7

Connecting Cables 8

Power Consumption 12

Ground Wiring 13



Operation

Turning Your Inverter On or Off 14

Remote On/Off Switch 15

Operating Indicators 16

Operating Limits 19

Troubleshooting Guide 20

Specifications 21



Warranty

Warranty 22



Customer Assistance

Maintenance 23

Product Service 23

Accessories and Order Form 24

Introduction

Important Safety Information

Important Safety Information

Before installing and using your Cobra power inverter, please read these general precautions and warnings.

Caution and Warning Statements

To make the most of this inverter, it must be installed and used properly. Please read the installation and operating instructions carefully before installing and using it. Special attention must be paid to the **CAUTION** and **WARNING** statements in the manual.



CAUTION Statements specify conditions which could cause damage to the unit or other equipment.



WARNING Statements identify conditions that could result in personal injury or loss of life.

General Precautions

1. **Never install the inverter in a boat's engine compartment where gas and battery fumes are present.**
2. Do not operate the inverter if it has been dropped or damaged in any way.
3. Do not open the inverter; it contains no user-serviceable parts. Attempting to service unit could cause electrical shock.



NOTE Internal components remain charged after all power is disconnected.

4. Do not expose the inverter to rain, snow, bilge water or spray.
5. Do not obstruct the ventilation openings.
6. Do not install the inverter in zero-clearance compartment.



CAUTION This inverter should be used in **negative ground** applications only.

Introduction

Important Safety Information

WARNING Power inverters contain components that tend to produce arcs or sparks. To prevent fire or explosion, do not install the inverter in areas or compartments containing batteries or flammable materials or in locations that require ignition-protected equipment.

WARNING To reduce the risk of fire, do not cover or obstruct the ventilation openings. Do not install inverter in zero-clearance compartment.

Caution: Rechargeable Appliances

Certain chargers for small nickel cadmium batteries can be damaged if connected to the Cobra 2500 watt inverter. Two particular types of equipment are prone to this problem:

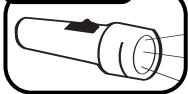
Plug In Directly

1. Small battery-operated appliances such as flashlights, razors, and night lights that can be plugged directly into an AC receptacle to recharge.

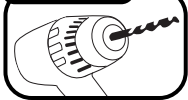
Dangerous Voltages

2. Certain battery chargers for battery packs used in hand power tools. These chargers have a **WARNING** label stating that dangerous voltages are present at the battery terminals.

This problem does not occur with the vast majority of battery operated equipment. Most use a separate charger or transformer that is plugged into the AC receptacle and produces a low voltage output. If the label on the AC adapter or charger states that it produces a low voltage AC or DC output (less than 30 volts), the inverter will have no problem powering the adapter safely.

2

Introduction

Important Safety Information**Cobra 2500 Watt Output Waveform**

Some very sensitive electronic equipment may not operate satisfactory on “square wave” or “modified sine wave.”

The output waveform is referred to as “square wave” or “modified sine wave.” It is a stepped waveform designed to have characteristics similar to the sine wave shape of utility power.

A waveform of this nature is suitable for most AC loads (including linear and switching power suppliers used in electronic equipment, transformers and motors).

Nothing Comes Close to a Cobra™

3

Quick Evaluation Before Installation

Quick Evaluation Before Installation

This section provides you with basic information about the inverter and how to check its performance before installation.

Be sure to have on hand:

- A 12 volt DC power source (such as a vehicle battery).

Power Source



The power source must provide between 11 and 15 volts DC and be able to supply enough current to run the test load. As a rough guide, divide the wattage of the test load by 10 to get the current (in amperes) the power source must deliver.

- Cables to connect the power source to the inverter (not included).

The cables must be as short and thick as possible in order to reduce the voltage drop between the power source and the inverter when it is drawing current from the power source.

If the cable suffers an excessive voltage drop, the inverter may shut down when drawing higher currents because the voltage at the inverter dropped below 10 volts.

#4 AWG stranded copper cable is recommended. It should be no longer than four feet (one and one-half meters).

The end of the cable that connects to the inverter must have its insulation stripped off for about one-half inch (one and one-half cm) back from the end, exposing the bare copper.

The other end of the cable, which connects to the power source, must be terminated with a lug or other connector that provides a secure, low resistance connection.

For example, if the power source is a battery, the cable must be terminated with a battery terminal that clamps to the post on the battery.

Quick Evaluation Before Installation

- A test load that can be plugged into the AC receptacle on the inverter for short term testing at a low power level. The following cables are recommended for testing low power level test loads only.

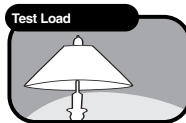

Test Load Power

| Test Load Power | Minimum Cable Size |
|-----------------|--------------------|
| 100W | # 16 AWG copper |
| 250W | # 12 AWG copper |
| 500W | # 8 AWG copper |

Minimum Cable Size

To check your inverter's performance before installation:

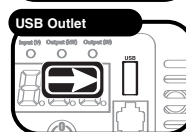
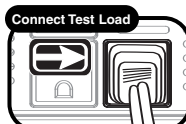
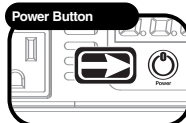
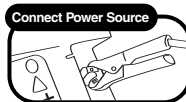
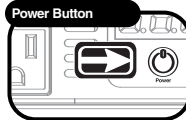

1. Turn the inverter **off** (see page 14 for details). If the power source is a DC power supply, switch it **off** as well.
2. Connect cables to power input terminals (see page 8 for details).
3. Connect cables to power source (see page 8 for details).
4. Check to make sure all connections are secure.
5. Turn the inverter **on**. If the power source is a DC power supply, switch it **on** first.
6. Plug in the test load.

The inverter should supply power to the load. If the inverter is not working properly, refer to the troubleshooting guide on page 20 or power and protection indicators section on page 16.



NOTE A USB device can be used to check the output of the USB Outlet.



Installation Requirements

Installation Requirements

The inverter must be installed in an area that meets all of the following requirements:

A. Dry

Do not place in an area where water can drip or splash on the inverter.

B. Cool

Ambient air temperature should be between 30°F and 105°F (0°C and 40°C). The cooler the better.

C. Ventilate

Allow at least one inch (three cm) of clearance around the inverter for proper airflow. Make sure that ventilation openings on the ends of the unit are not obstructed.

D. Safe

Do not install the inverter in the same compartment as a battery or in any compartment that contains flammable liquids such as gasoline.

E. Close to Battery

Install unit as close to battery as possible (without being in the same compartment) to minimize the length of cable required to connect the inverter to the battery. It is better and cheaper to run longer AC wires than longer DC wires (cables).



CAUTION To avoid fire, do not cover or obstruct ventilation openings. Do not install inverter in a zero-clearance compartment. Overheating may result.

CAUTION The inverter must only be connected to batteries with a nominal output voltage of 12 volts. It will not work with a 6 volt battery, and will be damaged if it is connected to a 16 volt battery.



Mounting



WARNING This unit contains components which can produce arcs or sparks. To prevent fire or explosion, do not install in compartments containing a battery or flammable materials, or in a location which requires ignition protected equipment.

WARNING This unit is suitable for installation in negative ground applications only. Do not attempt to install to a positive ground application.

Mounting

To mount your inverter:

1. Place the inverter on a flat surface with the mounting bracket against the mounting surface.

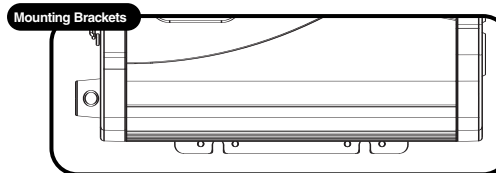

2. Mount to secure surface using mounting hardware that is corrosion resistant (not included).

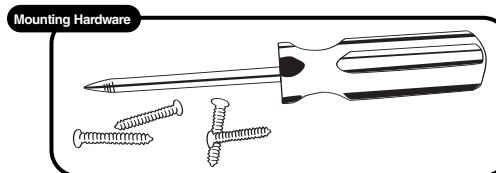

The inverter can be mounted horizontally or vertically. If mounted vertically, neither end of the unit should be at the top (to avoid foreign material from falling or settling into the unit).

Installation

Connecting Cables

Connecting Cables (not included)

Power wire and wiring are very important to the performance of the inverter. Because the inverter has a low voltage, high current input, low resistance wiring is essential between the battery and inverter. This is so it can deliver the maximum amount of energy to the load.

Use only copper wire. Aluminum wire has about one-third more resistance than copper wire of the same size, plus it is difficult to make good, low-resistance connections to aluminum wire.

We recommend #4 AWG copper cable (90°C insulation rating) as the minimum size for connections between the battery and inverter.

Keep the cable length as short as possible, no more than four feet (one and a half meters). This will keep the voltage drop to a minimum.

If the cable has too much voltage drop, the inverter may shut down when drawing higher currents because voltage at the inverter may drop below 10 volts. If you must use longer cables, choose thicker cables, such as #2 AWG, and trim the ends of the cable to fit the terminals.

To connect the cables between the inverter and the battery:

1. Press the **Power Button** on the inverter to the **off** position. If the power source is a DC power supply, switch it **off** as well.

Power Button

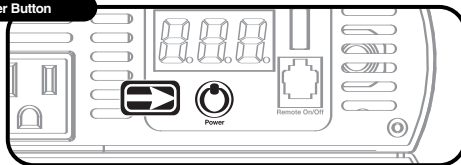

Installation

Connecting Cables

2. On the end of the cable that connects to the inverter, strip back the insulation about one-half inch (one and one-half cm), exposing the bare copper conductor.

Strip the Insulation

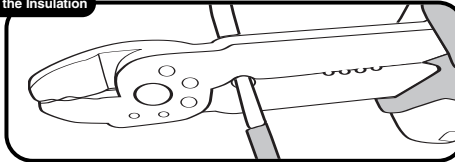

3. Connect cable to the **Power Input Terminals** on input end of the inverter. The red terminal is positive (+) and the black terminal is negative (-). Insert the bare ends of the cables into the terminals and tighten the screws to clamp the wires securely.

It is a good idea to check and tighten these screws from time to time. They can become loose by vibrations or thermal cycling.

Insert Bare Cables

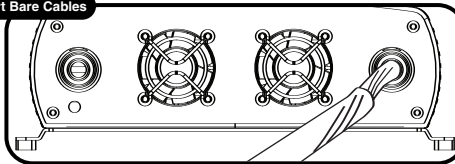

4. Connect cables to the power source:
 - a. Connect the cable from the **Negative (Black) Terminal** of inverter to the **Negative Terminal** of the power source. Make a secure connection.

Installation

Connecting Cables

- b. Connect the cable from the **Positive (Red) Terminal** of the inverter to the **Positive Terminal** of the power source (the battery's main fuse or the battery selector switch, if you are using one). Make a secure connection.

Connect Cables

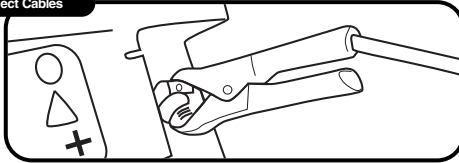

You might observe a spark when you make this connection since current can flow to charge capacitors in the inverter.

All power connections to your Cobra inverter must be **Positive to Positive** and **Negative to Negative**.



CAUTION Electrical installations must meet local and national wiring codes, and should be performed by a qualified electrician.

CAUTION Do not connect the inverter and another AC source (such as a generator or utility power) to the AC wiring at the same time. The inverter will be damaged if its output is connected to AC voltage from another source. Damage can even occur if the inverter is switched **off**.

CAUTION Do not connect the inverter to an AC branch circuit that has high-power consumption loads. It will not operate electric heaters, air conditioners, stoves, and other electrical appliances that consume more than 2500 watts.

CAUTION Loose connectors result in excessive voltage drop and may cause over heated wires and melted insulation.

CAUTION Reverse polarity connections (positive to negative) will blow internal fuses in the inverter and may permanently damage the unit. Such damage is not covered by the warranty.

10

Installation

Connecting Cables



CAUTION We recommend a main fuse in the battery's positive cable to protect against DC wiring short circuits (external to the inverter). The fuse should be as close to the battery as possible. We recommend a Buss Fuse ANL-250 or equivalent. The specific fuse ampere rating should be sized to allow operation of all your DC powered equipment.

CAUTION Remove any jewelry (watch, ring, etc.). Be careful not to short circuit the battery with any metallic object (wrench, etc.).



WARNING If you are making a permanent AC connection to the inverter, make sure that the AC wiring steps are performed before any DC wiring is done. (DC hook-up energizes internal components, regardless of the position of the **On/Off Switch**). Working on AC connections in such a circumstance may result in an electric shock.

WARNING 115 volt AC power is potentially lethal. Do not work on AC wiring when it is connected to the inverter (even if it is switched **off**) unless the DC power source is physically disconnected from the inverter. Also, do not work on AC wiring if it is connected to another AC power source such as a generator or the utility line.

WARNING You may observe a spark when making the connection because current can flow to charge the capacitors in the inverter. **Do not make this connection in the presence of flammable fumes.** Explosion or fire may result. Thoroughly ventilate the battery compartment before making this connection.

11

Installation

Power Consumption

Power Consumption

For each piece of equipment you will be operating from the inverter, you must determine the battery's **reserve capacity** (how long the battery can deliver a specific amount of current – in automotive batteries, usually 25 ampere) or **ampere-hour capacity** (a measure of how many amperes a battery can deliver for a specified length of time).

Example – Reserve capacity: a battery with a reserve capacity of 180 minutes can deliver 25 ampere for 180 minutes before it is completely discharged.

Example – Ampere-hour capacity: a battery with an ampere-hour capacity of 100 ampere-hours can deliver 5 ampere for 20 hours before it is completely discharged.

To determine the battery ampere-hour capacity you require:

1. Determine how many watts each piece of equipment consumes. This can normally be found on the product label. If only the current draw is given, multiply the current draw by 115 to get the watt consumption.
2. Estimate the time (in hours) that each piece of equipment will be running between battery charging cycles.
3. Calculate the total watt-hours of energy consumption (power x operating time) using the average power consumption and the total estimated running time (in hours). **Power x Operating Time = Watt-Hours.**

Laptop



100 watts x 2 hours
= 200 watt-hours

TV/VCR (up to 25")



115 watts x 3 hours
= 345 watt-hours

Blender



300 watts x 15 minutes
= 75 watt-hours

4. Divide the watt-hours by 10 to determine how many battery (12 volt) ampere-hours will be consumed.

Installation

Ground Wiring

Ground Wiring

There is a screw on the rear panel for **Chassis Ground**. This is to connect the chassis of the inverter to ground.

The **Chassis Ground Screw** must be connected to a grounding point, which will vary depending on where the unit is installed. Use a #8 AWG copper wire (preferably with green/yellow insulation) to connect the chassis ground screw to the grounding point.

Chassis Ground

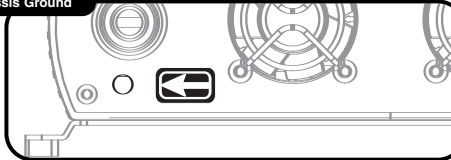

In a vehicle: Connect the **Chassis Ground** to the chassis of the vehicle.

In a boat: Connect to the **Boat Grounding System**.

In a fixed location: Connect the **Chassis Ground Screw** to earth ground by connecting to a ground rod (a metal rod pounded into the earth) or other proper service entrance ground.

Operation

Power On and Off

Turning Your Inverter On or Off

Be sure to have your power inverter properly installed before attempting to turn the unit **on** (see installation page 6).

To turn the power inverter on:

1. If a DC power supply is being used as the power source, switch it **on**.
2. On the **Output End**, press the **Power Button** to **on**.

Power Button

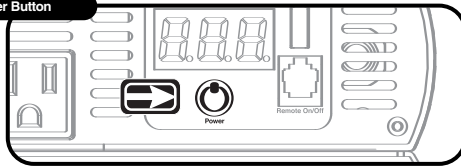

The inverter is now ready to deliver AC power to your loads. If several loads are to be operated by the inverter, turn them **on** separately, after the inverter has been turned **on**. This will ensure that the inverter does not have to deliver the starting currents required for all the loads at once.

NOTE The **Power Button** turns the control circuit in the inverter **on** and **off**. It **does not** disconnect power from the inverter.

When the button is in the **off** position, the inverter draws no current from the battery. When it's in the **on** position, but no power is being supplied to a load, the inverter draws less than 600 milliamperes from the battery. This is low current draw. It would take more than a week to discharge a 100 ampere-hour battery at this rate depending on the age of the battery.

Operation

Remote On/Off Switch

Remote On/Off Switch

An optional **Remote On/Off Switch** (see page 24 to order accessories) can be connected to the **Remote Jack** allowing you to turn the Cobra power inverter **on** or **off** from a convenient location when the inverter is installed in an out of reach location.

Remote Switch

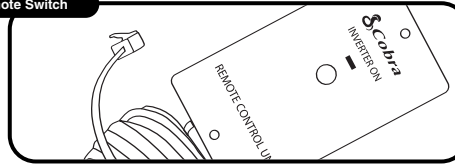

Remote Jack

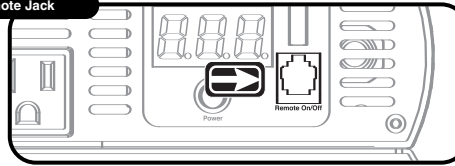

Operation

Operating Indicators

Operating Indicators

Indicators at the **Output End** of the unit show the unit's power status and alarms for conditions that could cause it to shut down.

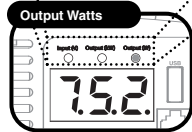
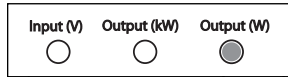

Power on – The Voltage Input and Power Output indicators automatically toggle between input and output values at three-second intervals. The three LEDs indicate the mode the meter is in and the three digits indicate the voltage or power value.

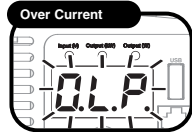

Current Overload Protection – If the inverter is overloaded, it will shut down to protect itself. The meter will flash as shown to indicate Overload Protect.

To restore normal operation, disconnect the excessive load and turn the unit **Off** and **On** again using the **Power Button**.

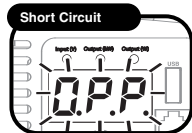

Short Circuit Protection – If the AC output of the inverter is short-circuited for one second or more, it will shut down to protect itself. The meter will flash as shown to indicate Short Circuit Protect and an alarm will sound.

To restore normal operation, disconnect the short circuit and turn the unit **Off** and **On** again using the **Power Button**.

Operation

Operating Indicators

Low Voltage



Low Voltage Protection – If the DC input voltage drops below the alarm threshold of 10.5V the meter will flash as shown to indicate Low Voltage Protection, but the unit will continue to operate. If the input voltage drops to 10.0V or less, the inverter will shut down to protect itself, the meter will continue to flash as shown, and an alarm will sound.

To restore normal operation, return the DC input voltage to at least 12V. The inverter will automatically return to normal operation.

High Voltage

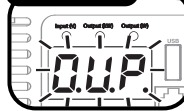

High Voltage Protection – If the DC input voltage rises above 15.0V, the inverter will shut down to protect itself, the meter will flash as shown to indicate Over Voltage Protection, and an alarm will sound.

To restore normal operation, return the DC input voltage to less than 15V. The inverter will automatically return to normal operation.

Operation

Operating Indicators

High Temperature

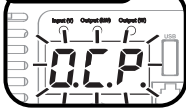

Over Temperature Protection –

If the internal inverter temperature rises above the alarm threshold, the meter will flash as shown, an alarm will sound to indicate Over Temperature Protect, and the unit will continue to operate. If the internal temperature rises to 40°C (104°F), the inverter will shut down to protect itself, the meter will flash as shown and the alarm will continue to sound.



NOTE Internal inverter temperature can rise due to being operated in a high heat environment or due to the fan or vents being blocked during operation (even in relatively cool outside air).

To restore normal operation, turn the unit **Off** and allow it to cool. The inverter will automatically return to normal operation after it has cooled.

Operation

Operating Limits

Operating Limits

Power Output

The inverter can deliver 2500 watts for about 60 minutes. The inverter must cool for 15 minutes before it can resume operation at 2500 watts. Note: The wattage rating applies to resistive loads.

The inverter will operate most AC loads within its power rating. Some induction motors used in freezers, pumps, and other motor-operated equipment require very high surge currents to start. The inverter may not be able to start some of these motors even though their rated current draw is within the inverter's limits. The inverter will normally start single phase induction motors rated at one-half HP or less.

Input Voltage

The inverter will operate from input voltage ranging from 10 volts to 15 volts. Optimum performance will occur when the voltage is between 12 volts and 14 volts. If the voltage drops below 10.5V \pm 0.3V, an audible low battery warning will sound. The inverter will shut down if the input voltage drops below 9.5V \pm 0.3V. This protects the battery from being over-discharged. It will restart when the input voltage exceeds 12V \pm 0.3V.

The inverter will also shut down if the input voltage exceeds 15.5V \pm 0.5V. This protects the inverter against excessive input voltage. Although the inverter has protection against over-voltage, it may still be damaged if the input voltage were to exceed 16 volts.

Operation

Troubleshooting Guide

Troubleshooting Guide

| Problem/Symptom | Possible Causes | Solution |
|--|------------------------------|---|
| Low output voltage | Overload | Reduce the load. |
| No output voltage | Low input voltage | Recharge battery. Check connections and cable. |
| No output voltage after prolonged use | Thermal shutdown | Allow inverter to cool off. Reduce load, continuous operation input current required. Improve ventilation; Make sure ventilation openings in the inverter are not obstructed. Reduce ambient temperature. |
| No output voltage, "Protect" indicator lighted | High input voltage | Make sure the inverter is connected to 12V battery. Check regulation of charging system. |
| No output voltage | Short circuit | Check load for proper operation. |
| No output voltage | Inverter switched off | Turn inverter on . |
| | No power to inverter | Check wiring to inverter. |
| | Reverse DC polarity | Observe correct polarity. |
| Low battery alarm on all the time | Poor DC wiring | Check connections. |
| | Poor battery condition | Make sure battery is fully charged. |

Operation

Specifications

Specifications

| | |
|----------------------------------|---|
| Continuous output power (1 hour) | 2500W |
| Surge rating (0.1 second) | 5000W |
| Peak efficiency (12V – 1/2 load) | > 88% |
| Efficiency (full load, 12V) | > 83% |
| No load current draw | < 0.6A (12.6V) |
| Output waveform (resistive load) | Modified sine wave |
| Output frequency | 58HZ – 62HZ |
| Output voltage | 109V – 120V |
| USB output | 5V |
| Input voltage | 10.4VDC – 14.4VDC |
| Alarm voltage (unload) | 10.2V – 10.8V |
| Shutdown voltage (unload) | 9.2V – 9.8V |
| Operating temperature range | 0°C – 40°C (32°F – 104°F) |
| Storage temperature range | -40°C – 85°C (-40°F – 185°F) |
| Protection | Overload, short-circuit, overtemp, reverse polarity, under/over voltage |

Notes

All protection is automatically recovered.

To protect the battery, if the unit needs to be restarted after low voltage protection, the voltage of DC input should be above 12V.

To extend the life of the fan, it will stop when there is no load. The speed of the fan increases as the load increases.

The unit is completely insulated in input and output for added safety.

Warranty

Warranty and Trademark Acknowledgement

Limited Two-Year Warranty

For Products Purchased in the U.S.A.

Cobra Electronics Corporation warrants that its Cobra power inverter, and the component parts thereof, will be free of defects in workmanship and materials for a period of two years from the date of first consumer purchase. This warranty may be enforced by the first consumer purchaser, provided that the product is utilized within the U.S.A.

Cobra will, without charge, repair or replace, at its option, defective power inverters, products or component parts upon delivery to the Cobra Factory Service department, accompanied by proof of the date of first consumer purchase, such as a duplicated copy of a sales receipt.

You must pay any initial shipping charges required to ship the product for warranty service, but the return charges will be at Cobra's expense, if the product is repaired or replaced under warranty. This warranty gives you specific legal rights, and you may also have other rights which may vary from state to state.

Exclusions: This limited warranty does not apply:

1. To any product damaged by accident.
2. In the event of misuse or abuse of the product or as a result of unauthorized alterations or repairs.
3. If the serial number has been altered, defaced, or removed.
4. If the owner of the product resides outside the U.S.A.

All implied warranties, including warranties of merchantability and fitness for a particular purpose are limited in duration to the length of this warranty. Cobra shall not be liable for any incidental, consequential or other damages; including, without limitation, to damages resulting from loss of use or cost of installation.

Some states do not allow limitations on how long an implied warranty lasts and/or do not allow the exclusion or limitation of incidental or consequential damages, so the above limitations may not apply to you.

For Products Purchased Outside the U.S.A.

Please contact your local dealer for warranty information.

Trademark Acknowledgement

Cobra®, Nothing Comes Close to a Cobra® and the snake design are registered trademarks of Cobra Electronics Corporation, USA. Cobra Electronics Corporation™ is a trademark of Cobra Electronics Corporation, USA.

Customer Assistance

Maintenance and Product Service

Maintenance

Very little maintenance is required to keep the inverter operating properly. The exterior of the unit should be cleaned periodically with a damp cloth to prevent accumulation of dust and dirt. At the same time, tighten the screws on the DC input terminals. Be sure vents and fans are free of dust or debris.

Product Service

For any questions about operating or installing this new Cobra product, or if parts are missing...**PLEASE CALL COBRA FIRST**...do not return this product to the store. See customer assistance on page A1.

If your product should require factory service, please call Cobra first before sending your power inverter. This will ensure the fastest turn-around time on your repair. You may be asked to send your power inverter to the Cobra factory.

It will be necessary to furnish the following to have the product serviced and returned.

1. For warranty repair include some form of proof-of-purchase, such as a mechanical reproduction or carbon copy of a sales receipt. If you send the original receipt, it cannot be returned.
2. Send the entire product.
3. Enclose a description of what is happening with the power inverter. Include a typed or clearly printed name and address of where the power inverter is to be returned.
4. Pack power inverter securely to prevent damage in transit. If possible, use the original packing material.
5. Ship prepaid and insured by way of a traceable carrier such as United Parcel Service (UPS) or Priority Mail to avoid loss in transit to:
Cobra Factory Service
Cobra Electronics Corporation
6500 West Cortland Street
Chicago, Illinois 60707 USA.
6. If the power inverter is in warranty, upon receipt of your power inverter, it will either be repaired or exchanged depending on the model. Please allow approximately three to four weeks before contacting Cobra for status. If the power inverter is out of warranty, a letter will automatically be sent informing you of the repair charge or replacement charge.

If you have any questions, please call 773-889-3087 for assistance.



Customer Assistance

Accessories and Order Form

Remote On/Off Switch (CPI A20)



An optional **Remote On/Off Switch** can be connected to the **Remote Jack** allowing you to turn the Cobra CPI 2575 inverter **on or off** from a convenient location when the inverter is installed in an out of reach location.

 Name

 Address (No P.O. Boxes)

 City State/Province Zip Country

 Telephone

 Credit Card Number Type: Visa Mastercard Discover Exp. Date

 Customer Signature

Optional Accessories

You can find quality Cobra products and accessories at your local Cobra dealer, or in the U.S.A., you can order directly from Cobra.

Ordering from U.S.A.

Call 773-889-3087 for pricing or visit www.cobra.com.

For credit card orders, complete and return this order form to fax number 773-622-2269. Or call 773-889-3087 (Press 1 from the main menu) 8:00 a.m. to 6:00 p.m. CT, Monday through Friday.

Make check or money order payable to:
Cobra Electronics, Attn: Accessories Dept.
6500 West Cortland Street, Chicago, IL 60707 USA

To order online, please visit our website: www.cobra.com